

### Open Frame Touch Monitor

#### HO 165 PTB

39,6 cm / 15.6" Diagonale  
LED Backlight – Format 16:9

- 1920 x 1080 Auflösung Full HD 1080P
- 10-Punkt Touch, P-Cap Technologie
- 170° weiter Betrachtungswinkel
- Eingänge: HDMI, DP, VGA
- **IP65 (vorne) Schutzart**
- **Display Schutz: Dicke 3.9 mm**
- **Betriebsdauer 24/7**
- **Eingebaute Stereolautsprecher**
- Touch-Through Glass Funktion
- Robustes Metallgehäuse
- VESA Aufnahme, weitere Montagemöglichkeiten
- Edge-to-Edge True Flat Design
- Ausrichtung: Quer, Hochformat, Face-Up

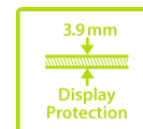
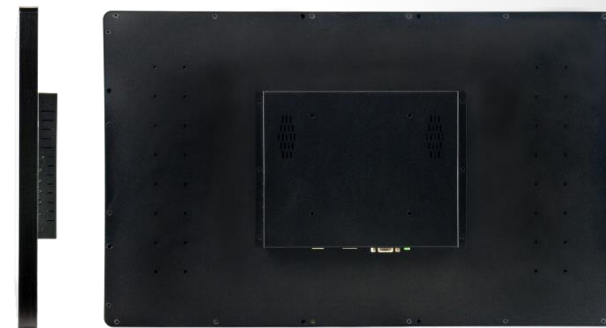

39,6 cm / 15.6"

Part. No.: HO 165 PTB

#### Größe, Auflösung



15.6" - 16:9  
Seitenverhältnis



Full HD  
1920 x 1080

#### Anschlüsse, IP Schutzart



VGA  
HDMI  
Display Port



IP 65, Wasser und  
Staub Schutz

#### Betrachtungswinkel, VESA

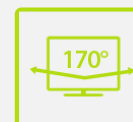

170° weiter  
Betrachtungswinkel



Wandmontage  
VESA

#### Andere Eigenschaften



Betriebsdauer  
24/7



Eingebaute  
Stereolautsprecher

Bildschirmgröße	39,6 cm / 15.6" Diagonale
Panel Typ	TFT – LED Backlight
Seitenverhältnis	16:9
Auflösung (H x V)	1920 x 1080 Full HD
Helligkeit (Nativ)	250 cd/m <sup>2</sup> (Panel) – 212 cd/m <sup>2</sup> (Monitor)
Kontrast (Nativ)	700:1 (Nativ) – 10M:1 (Aktiv)
Display Bereich	345,23 x 194,54 mm
Betrachtungswinkel L/R; O/U	170° H / 170° V (CR > 10)
Reaktionszeit	25 ms
Pixelabstand	0,17925 (H) X 0,17925 (V) mm
Touch Technologie	Projected Capacitive Type – 10 Punkt Touch Material Glass + Glass Cover Glass+LOCA+ITO (Indium Tin Oxide) Glass
Bildschirmfarben	262K Farben
Horizontale Frequenz	31.5 ~ 80 kHz
Vertikale Frequenz	60 ~ 75 Hz
Max. Monitor Frequenz	1920 x 1080 @ 60Hz
Eingang 1	VGA
Eingang 2	HDMI
Eingang 3, 4	Display Port / USB (Touchfunktion)
Eingebaute Lautsprecher	Ja, 1,5W x 2
Energieverbrauch	An: 7,3W; Stand-by: 0,4W; Aus: 0,2W
Stromquelle	Externes Netzteil: 12 Volt / 2,5A Eingang: AC 100 ~ 240 Volt; 50 ~ 60 Hz
Produktmaße	387,3 x 236,4 x 39,8 mm (B x H x T)
Verpackungsmaße	464 x 325 x 100 mm (B x H x T)
Netto / Brutto Gewicht	2,46 Kg / 4 Kg (± 0,3 Kg)

VESA Aufnahme	100 x 100 mm. Schrauben:: M4, 10mm (Max), Gewindesteigung 0,7 mm
Display Schutz	Dicke 3,9 mm
Hartglasschutz	Härte ≥6H / ≥85%
IP Schutzart	IP 65 * (Vorne), Wasser und Staub Schutz
Bedienelemente	Menü/Ausgang,Hell. (+),Vol (-) , Eingang/Enter,Power
LED Backlight Lebensdauer	15.000 Stunden
Zubehör	Netzteil mit EU und UK Kabel (1,5m); HDMI Kabel (1,5m); USB 2.0 (B-A) Kabel für Touchfunktion (1,8m)
Bildschirmanzeige	8 OSD Sprachen
Farbeinstellungen	9300, 6500, 5300, User Mode
Voreinstellungen	Standard, Text, Movie, Game Modes
Ausrichtung	Quer, Hochformat, Face-Up

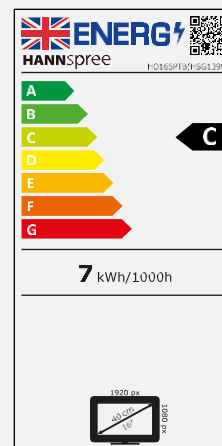
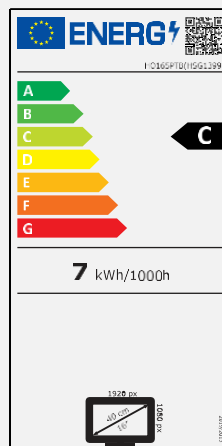

Herstellername	HANNSpree
Modellname	HO165PTB
Energieeffizienzklasse für Standard Dynamic Range (SDR)	C
Energieeffizienzklasse für Standard Dynamic Range (SDR) (kWh/1000h)	7 kWh/1000h
Leistungsaufnahme im Betrieb	7,3 W
Leistungsaufnahme in ausgeschaltetem Zustand	0,2 W
Leistungsaufnahme im Standbybetrieb	0,4 W
Displaygröße (cm / Zoll)	39,6cm / 15.6"
Bildschirmauflösung	1920 x 1080

PART. NO.:  
HO 165 PTB



4 711404 023033 >

\* IP65: The IP Code classifies how resistant a device is to foreign objects and moisture. IP65 means that the monitor is protected from total dust ingress and it is protected against low pressure water jets from any direction. Limited ingress permitted.

**HANNSpree**

**HO 165 PTB**  
**15.6" Open Frame Touch Monitor**

Experts in **Display**



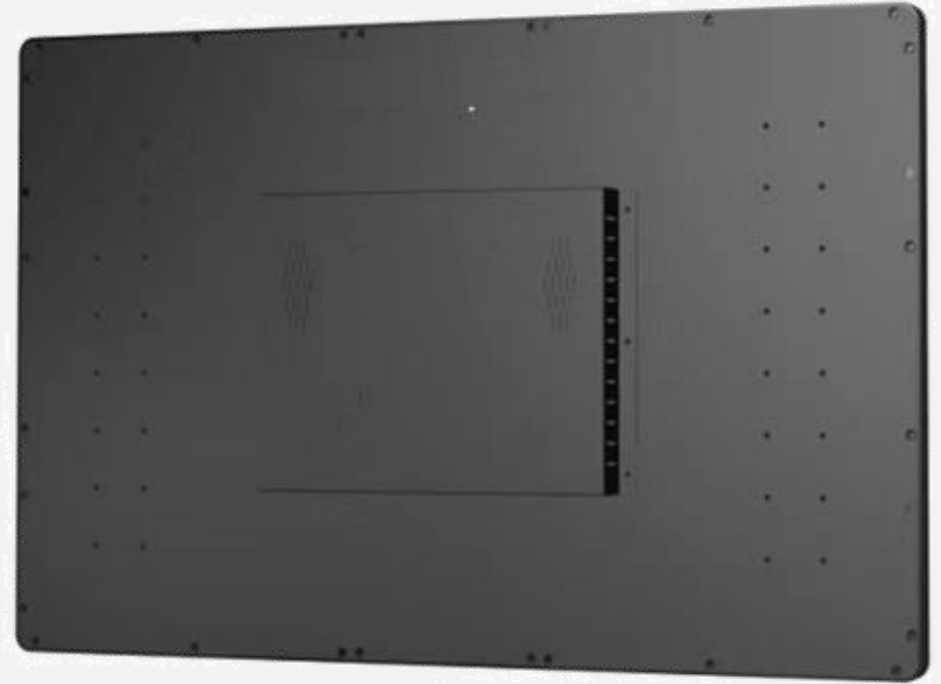
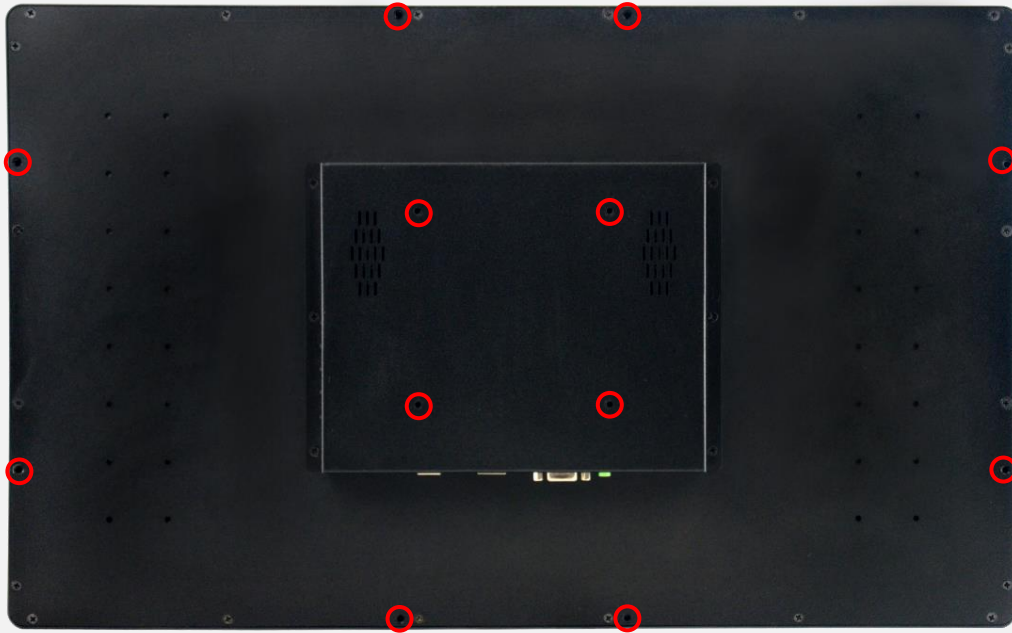

**Front Cover :**

**Full Flat Design**

Screws: M4 x 10mm (max), pitch 0.7, UNC type

## HO 165 PTB 15.6" Open Frame Touch Monitor

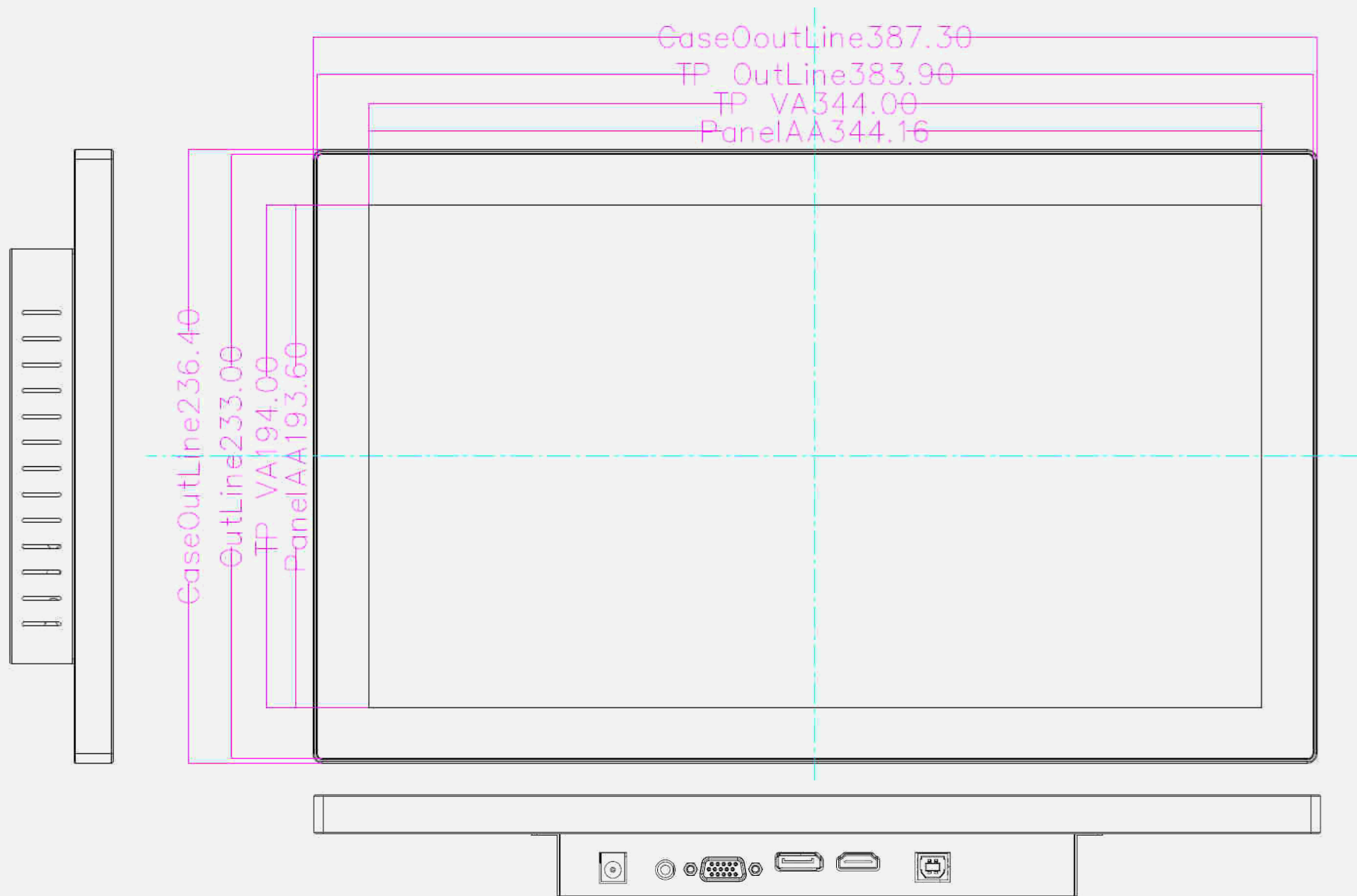

## HO 165 PTB 15.6" Open Frame Touch Monitor

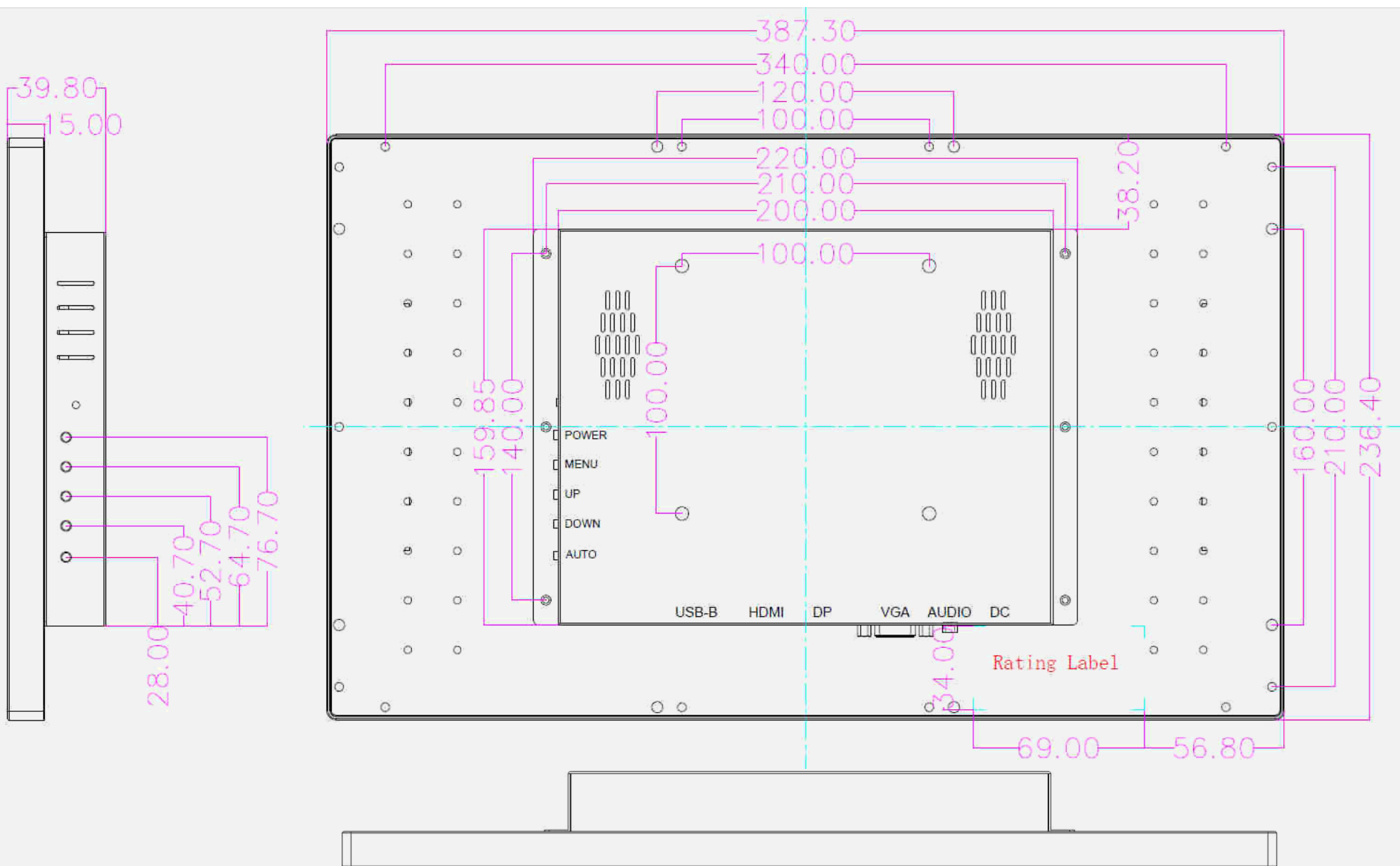

**HANNspree**

**HO 165 PTB**  
**15.6" Open Frame Touch Monitor**

Experts in **Display**

